

Tmedia

TMG800 System Installation Guide

9010-00206-1A , Issue 1.0



The information in this document is subject to change without notice. No part of this document may be reproduced or transmitted in any form or by any means, electronic or mechanical, for any purpose, without the express written permission of **TelcoBridges**. **TelcoBridges** may have patents or pending patent applications, trademarks, copyrights, or other intellectual property rights covering subject matter in this document. The furnishing of this document does not give you license to these patents, trademarks, copyrights, or other intellectual property except as expressly provided in any written license agreement from TelcoBridges.

The information provided in this document is intended as a guide only. For the latest detailed engineering specifications, please contact **TelcoBridges** Customer Support. **TelcoBridges** is committed to continually improving product designs; as a result, product specifications may be subject to change without notification.

© 2003-2009 **TelcoBridges**. All rights reserved.

TelcoBridges, *Tmedia*, TMP6400, TMG3200, TMS1600 Switch, TMP800, TMG800, *Toolpack API*, On a Blade, System-Blade, TB-1+1 Solution, TB-16-E1/T1/J1, TB640-DS3, TB640-E1/T1/J1, TB640-OC3/STM-1, TB-8-E1/T1/J1, TB-IVR Mezzanine, TB-Multi-Blade, TB-Multi-Blade Mezzanine, TB-N+1-15 Solution, TB-N+1-3 Solution, TB-StreamServer, TB-Video, TB-VoIP Mezzanine, TM-1000 Network Probe are trademarks of **TelcoBridges** Inc. All rights reserved 2009. All other trademarks are property of their owners. This information is subject to change without notice.

Document Title: TMG800 Installation Guide
Document Number:9010-00206-1A, Issue 1.0, 2009-10-08//01:07

HEAD OFFICE

91 rue de la Barre, Suite 01
Boucherville, Quebec
J4B 2X6, Canada

T +1 450 655 8993

F +1 450 655 9511

info@telcobridges.com

support@telcobridges.com

Preface

About this Guide

This guide describes the installation and setup of the Tmedia TMG800 telecom platform and the connections to voice, and IP networks.

Conventions

Terminology	Description
Tmedia Management Interface	This is the interface used to configure and manage the TMG800.
Tmedia Unit	A generic reference to the TMG800.

Contact Us

If you have comments about this guide or any other TelcoBridges technical documentation, please send an E-mail to support@telcobridges.com.

Table of Contents

Chapter 1	Introduction	1
	1.1 Installation Overview	2
	1.2 Installation Prerequisites	3
	1.3 Preventing Electrostatic Discharge Damage.....	3
	1.4 Recommended Reading	4
Chapter 2	Equipment Connections	5
	2.1 Package Contents.....	6
	2.1.1 TMG800 Package Contents.....	6
	2.2 Rack mounting the TMG800	7
	2.2.1 Prerequisites	7
	2.2.2 Vertical Placement of Tmedia Equipment	7
	2.2.3 Mounting the TMG800	8
	2.3 Connecting to the Tmedia Management Interface	9
	2.3.1 Prerequisites	9
	2.3.2 Interconnections.....	9
	2.4 Connecting to a VoIP Network	10
	2.4.1 Prerequisites	10
	2.4.2 Connections	10
	2.5 Connecting to the PSTN	11
	2.6 Powering Up.....	12
	2.6.1 Prerequisites	12
	2.6.2 Connecting to AC Power	12
	2.6.3 Connecting to DC Power.....	13
	2.6.4 Verifying the LED Status Indications.....	14
Chapter 3	Initial System Configuration	17
	3.1 Configuring the TMG800.....	18
	3.2 Setting the Time Zone.....	19
	3.3 Configuring the Toolpack System Using the Web Portal	19
	3.4 Changing the TMG800 Host IP	20
	3.5 Changing VoIP Interface Addresses	20
	3.6 Changing Passwords	20
Chapter 4	System Upgrades.....	21
	4.1 Installing a New License	21
Chapter 5	Troubleshooting Tools.....	23
	5.1 Connecting to the Serial Port of the TMG800	24
	5.2 Configuring the Terminal Emulator Application.....	26
	5.3 Reporting a Problem	27
	5.4 Setup Information.....	27

5.5	Tbdebug Dump Files (Mandatory).....	27
5.6	Application Logs.....	27
5.7	Backdoor Tools	28
5.7.1	tbx_cli_tools_remote	28
5.7.2	Line/Trunk Status (Tbshows).....	29
5.7.3	VoIP Traffic Capture.....	29
5.7.4	Wireshark (formerly called Ethereal).....	29
5.7.5	Tbstreamlisten.....	30
5.7.6	Stream Server Audio Packets to Wave File	30
5.7.7	tbsigtrace Signaling Traces	30

Chapter 1 Introduction

This chapter provides an introduction to the installation and setup of the TMG800.

The following topics are covered:

- Installation overview
- Installation prerequisites
- Other recommended reading

1.1 Installation Overview

The installation and setup of the TMG800 consists of a procedures organized in the following order:

- Rack mounting the TMG800
- Connecting to the Tmedia management interface
- Connecting to the VoIP network
- Connecting to the PSTN
- Powering Up
- Initial System Configuration
- System Upgrades
- Troubleshooting

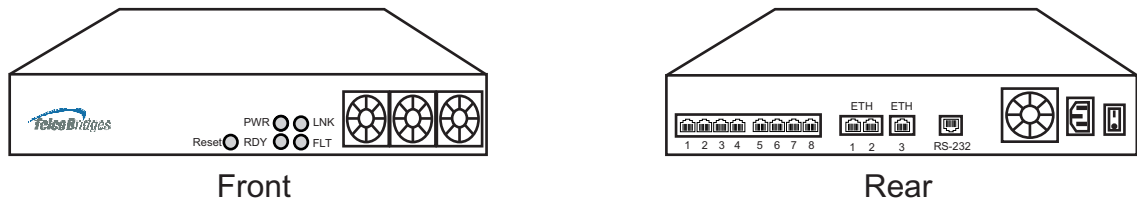

Figure 1.1 TMG800 front and rear views

1.2 Installation Prerequisites

In order for the TMG800 system installation to proceed without interruption, it is important that you verify that you have on hand all of the necessary materials. Prior to beginning the installation, you should have prepared for the following:

- Adequate space for the installation of your Tmedia system. Consider that you will need to mount the TMG800 on a 19" customer-provided equipment rack.
- Adequate power supply and power connections. In order to guarantee an uninterrupted supply, the TMG800 must be powered by a dedicated power source. Consider that a TMG800 will require one power connection in addition to PCs, servers, and Ethernet switches.
- In order to run your telecom applications on the TMG800, you will need to have purchased an adequate number of licenses for the features that you will use.

1.3 Preventing Electrostatic Discharge Damage

Electrostatic discharge (ESD) can damage equipment and impair electrical circuitry. It may occur if electronic printed circuit cards are improperly handled and may cause complete or intermittent failure.

Attention Always follow ESD prevention procedures when removing and replacing modules:

- Ensure that the TelcoBridges Tmedia units are electrically connected to earth ground.
 - Wear an ESD-preventive wrist strap and ensure that it makes good contact with your skin. Connect the wrist strap clip to an unpainted surface of the Tmedia unit or the grounded equipment rack in order to channel away all ESD voltage safely to ground. To guard against ESD damage and shocks, the wrist strap and cord must be in proper working condition.
 - If no wrist strap is available, and you must work with the Tmedia units, ground yourself by touching a metal part of the chassis.
-

1.4 Recommended Reading

This document assumes that you are well versed in the installation of TelcoBridges Tmedia units and have been trained to work with the equipment. If you have any technical questions, please contact TelcoBridges technical support or send an E-mail to support@telcobridges.com.

Other documents exploring various aspects of the Tmedia system are available on the TelcoBridges TB Wiki at: http://docs.telcobridges.com/mediawiki/index.php/Main_Page

Chapter 2 Equipment Connections

This chapter provides the procedures for the connection of a TMG800 to a Tmedia management interface, the PSTN and IP networks. Topics covered are:

- Verifying the List of Materials
- Rack mounting the TMG800
- Connecting to the Tmedia Management Interface
- Connecting to a VoIP network
- Connecting to a PSTN Network
- Connecting Power

2.1 Package Contents

You will have received a TMG800, a telecom platform on which you will run your telecom applications.

2.1.1 TMG800 Package Contents

In the TMG800 box, you will find:

- One TMG800
- One set of mounting brackets with screws. These are used for the mounting of a TMG800 on a 19" rack.
- One DB-9 to RJ-45 adapter. Allows you to interface the serial port of your computer with the RJ-45 console port of the TMG800. See pinout description in Section 5.1 "Connecting to the Serial Port of the TMG800" on page 24.
- Three RJ45 CAT5 Ethernet straight cables (male-male), three meters in length. One can be used to connect the console port to a terminal. The remaining two cables can be used to connect to VoIP networks.
- One warranty sheet
- One packing slip
- One TMG800 Quick Installation guide.

Not included with the TMG800:

- A power cord. Used to supply power to the TMG800.
- A 19" equipment rack. You will use a standard 19" wide equipment rack to install the TMG800.

2.2 Rack mounting the TMG800

The TMG800 is mounted on a customer provided equipment rack using the mounting hardware packaged in the box.

2.2.1 Prerequisites

To rackmount the TMG800, you will need:

- One 19" customer provided equipment rack. Racks must be solidly anchored to the floor with appropriate support at the top of the racks.
- Climate controlled room: 0 to +50 Celsius, 0 to 95% non-condensing humidity.

2.2.2 Vertical Placement of Tmedia Equipment

The TMG800 is housed in a 1U chassis, as tabulated in table 2.1 on page 7. It is important that you provide for enough room on the equipment rack to allow for the installation of the TMG800 and other related equipment. Consider the available space on your equipment rack and the individual heights of each unit. Due to the rear-exhaust heat vents and the efficient heat dissipation design, there is no need to leave any physical vertical space between the placement of the TMG800 on the equipment rack.

Table 2.1 Tmedia Physical Height

Tmedia Model Number	Vertical Height
TMG800	1U

2.2.3 Mounting the TMG800

The TMG800 is mounted on the 19" equipment rack using the angle brackets and screws provided in the box. To mount the hardware, proceed as follows:

To mount the TMG800, proceed as follows:

1. Using two metal screws, attach one angle bracket to the front, left-hand side of the TMG800 when viewed from the front, as shown in figure 2.1 on page 8. Repeat the same for the angle bracket on the right-hand side.
2. Mount the TMG800 on the rack, keeping in mind the space required on the equipment rack for other equipment as described in Section 2.2.2 "Vertical Placement of Tmedia Equipment" on page 7.

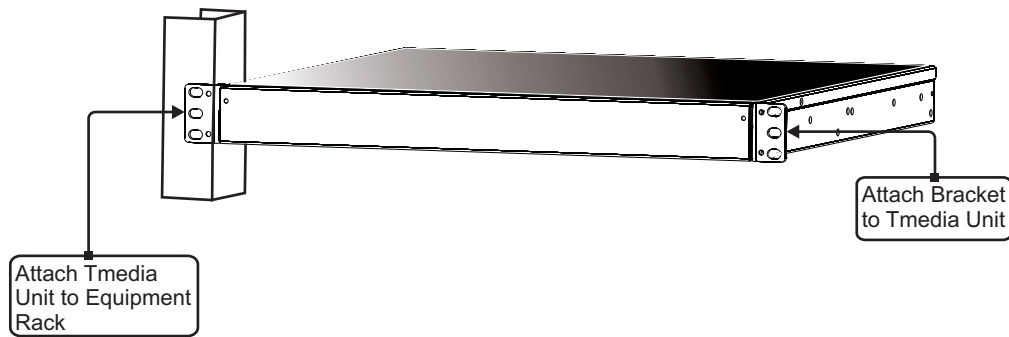

Figure 2.1 Mounting the TMG800

2.3 Connecting to the Tmedia Management Interface

The Tmedia Management Interface enables administrators to perform management tasks on the TMG800.

2.3.1 Prerequisites

To communicate with the Tmedia Management Interface, the following is needed:

- One CAT5 Ethernet cable with RJ45 male-male terminations.

2.3.2 Interconnections

The TMG800 provides a Tmedia Management Interface, using one Gigabit Ethernet network link, as shown in figure 2.2 on page 9.

To communicate with the Tmedia Management Interface:

1. Connect the supplied CAT5 Ethernet cable to the ETH3 at the rear of the TMG800.

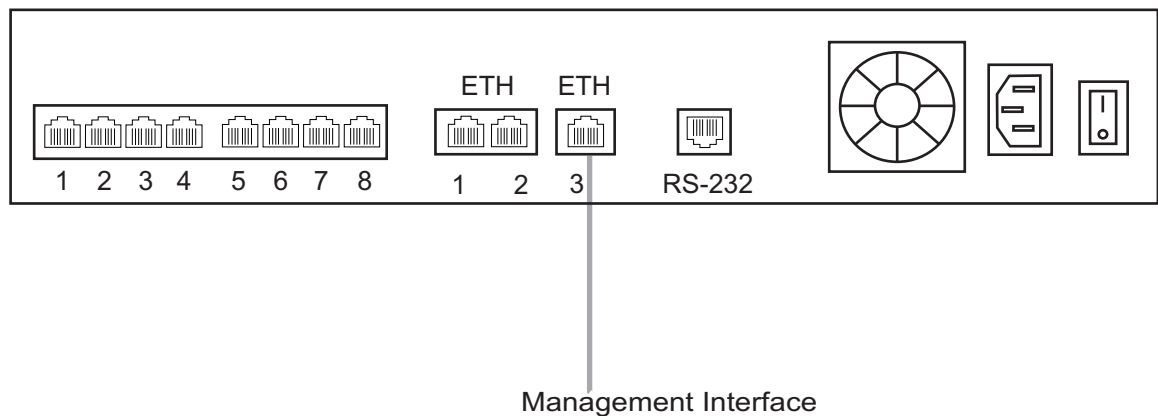

Figure 2.2 Tmedia Management Interface

Note Refer to Section 5.1 “Connecting to the Serial Port of the TMG800” on page 24, to change the IP address.

2.4 Connecting to a VoIP Network

The TMG800 features dual GigE ports for connection to different VoIP networks. This provides an access point to manage VoIP traffic. Should one of the IP networks fail, the TMG800 will continue to manage VoIP traffic using the alternate network.

Note: **Certain configurations of the TMG800 will exceed 100 Mbps, therefore 1000 Mbps is recommended.**

2.4.1 Prerequisites

To connect the TMG800 to the VoIP network, you will need:

- Gigabit Ethernet switch. A second one is required to support redundancy of the VoIP interface.
- One CAT5 Ethernet cable with RJ45 male-male terminations for each TMG800.
- If your system has access to a second VoIP network, you can connect it to a second VoIP interface of the TMG800 with an RJ45 (male-male) CAT5 Ethernet cable.

2.4.2 Connections

The TMG800 is connected to the VoIP network by one or optionally two Ethernet GigE network links, as shown in figure 2.3 on page 10.

To connect the TMG800 to the VoIP network:

1. Connect a CAT5 Ethernet cable to ETH1 at the rear of the TMG800. Connect the other end of the same CAT5 cable to the Gigabit Ethernet switch.
2. If your system employs a second Gigabit Ethernet switch for redundancy, connect a second CAT5 Ethernet cable to ETH2 at the rear of the TMG800. Connect the other end of the same CAT5 cable to the second Gigabit Ethernet switch.

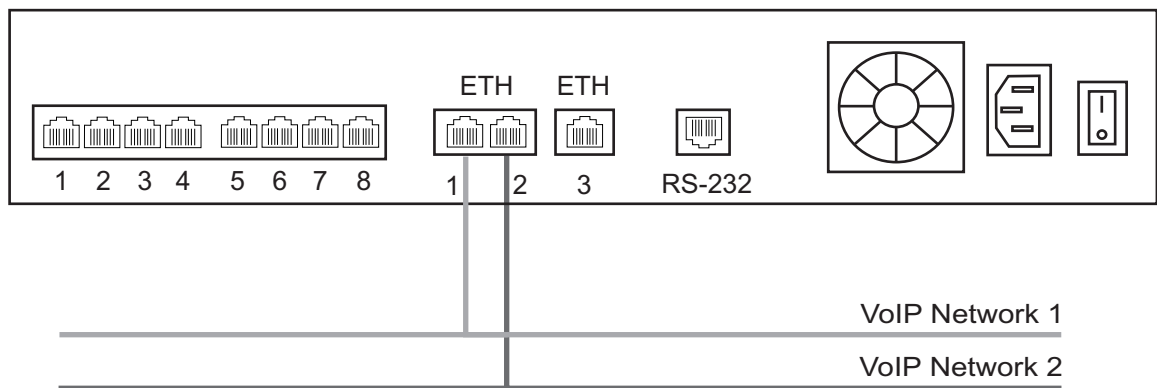

Figure 2.3 Connecting to the VoIP Network

2.5 Connecting to the PSTN

The TMG800 features 8 modular 8-conductor RJ48 type jacks for connection to T1/E1/J1 lines. You will need one cable for each (T1/E1/J1) interface on the TMG800.

The termination impedance is set at 100 ohms for T1 lines and 120 ohms for E1 lines. It is possible to connect an external balun in order to convert line impedances to 75 ohms.

Note All ports may not be active. T1/E1/J1 ports are activated by software license; the number of active ports depends on the licenses purchased.

To connect the TMG800 (RJ48 type) to the PSTN:

1. Start with port 1 located at the top and left-most position. Connect one cable between this port and the T1/E1/J1 line (figure 2.4 on page 11).
2. Repeat step 1, using the next available port.

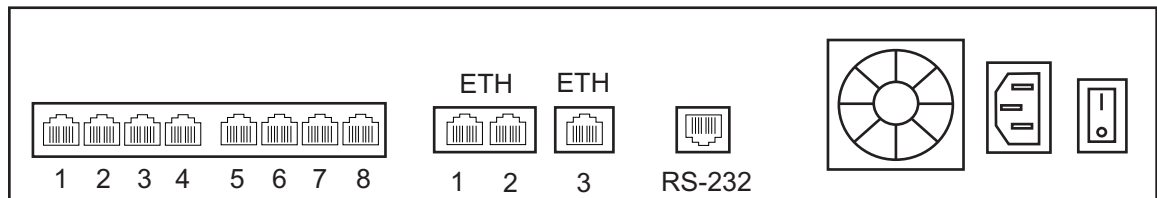

Figure 2.4

8-Port Interface to the PSTN

2.6 Powering Up

The TMG800 is furnished with one AC or DC termination points. Only once all other equipment installation work has been completed should the TMG800 be powered up.

2.6.1 Prerequisites

To power the TMG800, you will need:

- A dedicated power source for the TMG800.
- One power cable for the TMG800.

2.6.2 Connecting to AC Power

The TMG800 is furnished with one AC power connector (figure 2.5 on page 12).

To connect the TMG800 to AC Power:

1. Connect an AC power cable between the AC connector of the Tmedia unit and an AC supply. See figure 2.5 on page 12.
2. Power up the TMG800 by turning on the AC power switch.

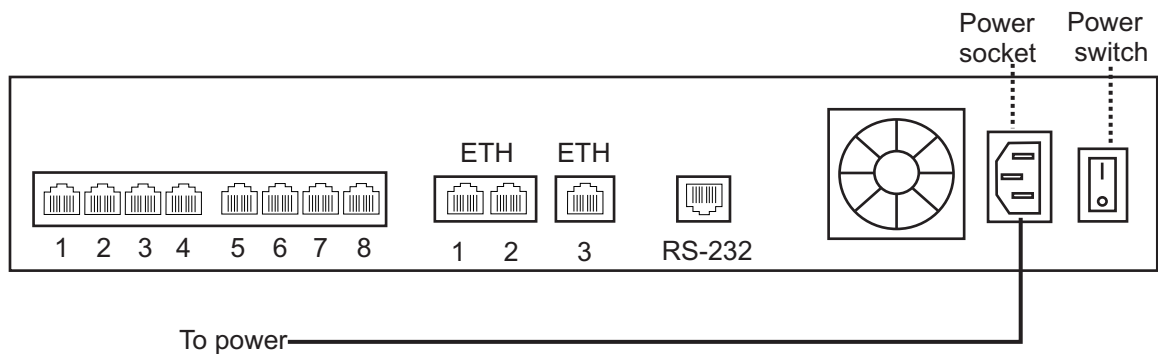

Figure 2.5 AC Power Connection

2.6.3 Connecting to DC Power

The TMG800 is furnished with one DC power connection port.

To connect the TMG800 to DC power:

1. Connect a ground wire to the ground lug located at the rear of the TMG800, as shown in figure 2.6 on page 13.
2. Connect a 14 AWG wire between the positive terminal of a DC power source and the terminal on the TMG800 labelled as --- .
3. Connect a 14 AWG wire between the negative terminal of a DC power source and the terminal on the TMG800 labelled as 48V.
4. Turn on the DC power source.

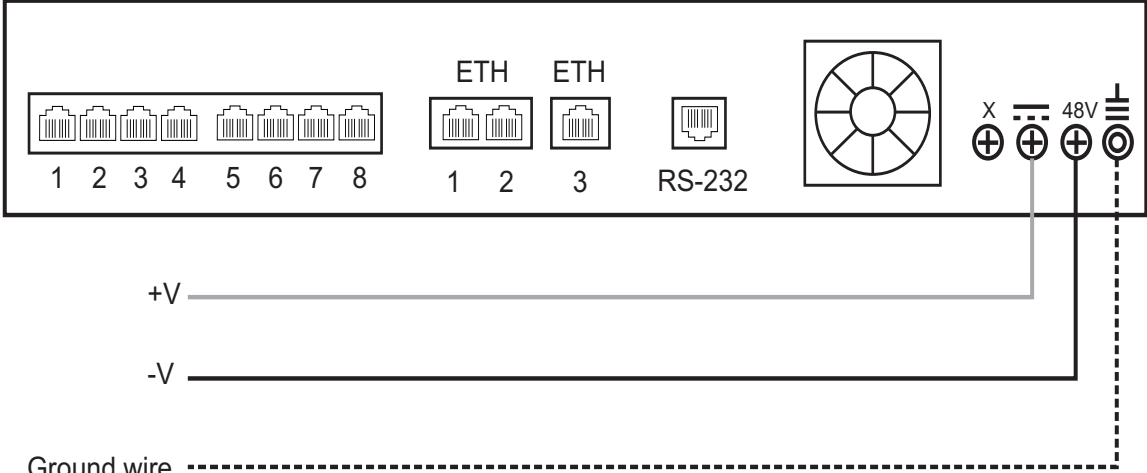

Figure 2.6 TMG800 DC wiring diagram

2.6.4 Verifying the LED Status Indications

Front of Unit

When the TMG800 has been powered, verify the front panel to determine that all indications are normal. See Table 2.2 on page 14.

Table 2.2 Tmedia Unit Displays

LED	Description
PWR	<ul style="list-style-type: none"> Off. Unpowered Steady Red. Initial Start Up Steady Green. Powered
RDY	<ul style="list-style-type: none"> Off. Not Ready Steady Red. On while the FPGAs are being programmed Blinking Red. Unit has failed during the boot up process. Blinking Orange. The unit will shut down in a few minutes. Blinking Green. The unit is booting up. Steady Green. The unit has successfully booted up.
LNK	<p>Provides status of the ETH-1 port link.</p> <ul style="list-style-type: none"> Off. While the FPGA is being programmed. Steady Red. No link detected on the management port. Steady Green. The link (10M, 100M, or 1000M) has been detected.
FLT	<ul style="list-style-type: none"> Off. While the FPGA is being programmed, or the software is being properly managed. Steady Red. An error has occurred. The customer should connect to the Tmedia Web Portal or use other debugging software.

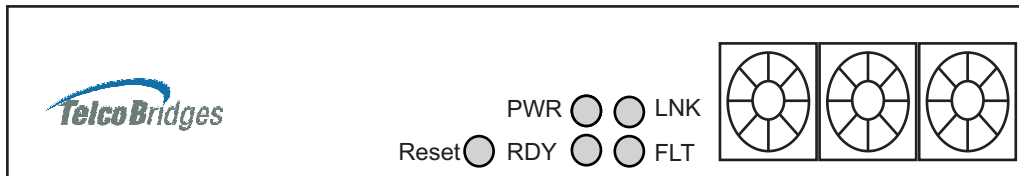

Figure 2.7 Front display and LEDs

Note Pressing the Reset button for 1 second will force the unit into a **graceful** shutdown. This will take a few minutes.

Pressing the reset button for 10 seconds will force the TMG800 into an **ungraceful** shutdown. This method should only be used in extreme cases.

Rear of Unit

When the TMG800 has been powered, verify the rear panel LEDs for each of the 8 trunks ports to assure that indications are normal. See Table 2.3 on page 15.

Table 2.3 Tmedia Rear Unit Displays

LED	Description
Yellow LED (Left Side of Trunk Port)	<ul style="list-style-type: none"> Off. No Loss of Signal (LOS) On. Loss of Signal (LOS)
Green LED (Right Side of Trunk Port)	<ul style="list-style-type: none"> Off. Loss of Frame (LOF) On. No loss of Frame (LOF)

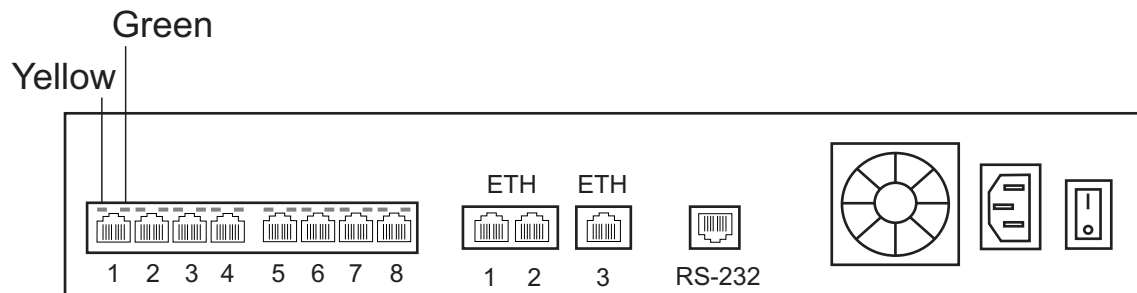

Figure 2.8 Rear Trunk Port Status LEDs

Chapter 3 Initial System Configuration

This chapter provides the initial procedures that are required in order for you to be able to configure your TMG800.

The following topics are covered:

- Configuring the TMG800
- Setting the Time Zone
- Configuring the Toolpack System Using the Web Portal
- Changing TMG800 Host IP Address
- Changing VoIP IP Interface Addresses
- Changing Passwords

3.1 Configuring the TMG800

The TMG800 comes with the Toolpack and Media Gateway applications pre-installed. In order to make changes to system configuration, you must connect the front port (labelled Ethernet) of the TMG800 to a terminal.

The IP address of the TMG800 is assigned automatically through DHCP, however, default configurations can be changed manually.

The default hostname is the serial number of the embedded host. This can be found on the packing slip along the “TM-CPU-HOST” item.

If the hostname is not known, it can be found using the front serial connection. Default login information is root/root. Type the command “hostname” or “ifconfig -a”:

```
[root@TB003540 ~]# hostname
```

```
TB003540
```

```
[root@TB003540 ~]# ifconfig -a
```

```
eth0 Link encap:Ethernet HWaddr 00:0C:38:00:0C:39
```

```
inet addr:10.0.0.236 Bcast:10.0.1.255 Mask:255.255.254.0
```

```
inet6 addr: fe80::20c:38ff:fe00:c39/64 Scope:Link
```

You can connect using the hostname or using the IP address assigned to eth0, using port 12358:

```
http://HOSTNAME:12358
```

For example: `http://TB003540:12358`

3.2 Setting the Time Zone

The time zone of the TMG800 is configured on the Linux host using the *tzselect* command. The following is provided as a sample of how to configure a time zone.

```
[root@TB005375 ]# tzselect
Please identify a location so that time zone rules can be set correctly.
Please select a continent
1) Africa
2) Americas
.
.
.
10) None - I want to specify the time zone using the Posix TZ format.
#? 2
Please select a country.
1) Anguilla
.
.
.
10) Canada
.
.
.
51) Virgin Islands (US)
#? 10
Please select one of the time zone regions.
1) Newfoundland Time, including SE Labrador
.
.
.
7) Eastern Time - Quebec - most locations
.
.
.
27) Pacific Time - north Yukon
#? 7

The following information has been given:

      Canada
      Eastern Time - Quebec - most locations

Therefore TZ= 'America/Montreal' will be used.
Local time is now: Wed Aug 19 08:49:01 EDT 2009.
Universal time is now: Wed Aug 19 08:49:01 UDT 2009.
Is the above information OK?
1) Yes
2) No
#? 1

You can make this change permanent for yourself by appending the line
      TZ= 'America/Montreal'; export TZ
to the file '.profile' in your home directory; then log out and log in again.

Here is the TZ value again, this time on standard output so that you
can use the /usr/bin/tzselect command in the shell script
America/Montreal
[root@TB005373 ]#
```

3.3 Configuring the Toolpack System Using the Web Portal

To change the default configuration of the Toolpack system using the Web Portal, follow the steps described in the Web Portal System Configuration Tutorial Guide. This document can be obtained from TelcoBridges TB Wiki at:

http://docs.telcobridges.com/mediawiki/index.php/Web_Portal_Tutorial_Guide

The default login information for the Web Portal application is:

- Username: root
- Password: root

3.4 Changing the TMG800 Host IP

A static IP address can be assigned to eth0, instead of using DHCP. To do this connect to the serial port (see Section 5.1 “Connecting to the Serial Port of the TMG800” on page 24) and open the eth0 configuration file, using the procedure described in the Telcobridges TB Wiki at:

http://docs.telcobridges.com/mediawiki/index.php/TBLinux:How_to_change_the_ip_address

To return ETH0 to using DHCP, open the ETH0 configuration file, using the same procedure described in the Telcobridges TB Wiki at:

http://docs.telcobridges.com/mediawiki/index.php/TBLinux:How_to_change_the_ip_address

3.5 Changing VoIP Interface Addresses

The default address of the VoIP interfaces of the TMG800 can be modified. To learn how this is done, refer to the Toolpack Web Portal tutorial guide on the Telcobridges TB Wiki at:

http://docs.telcobridges.com/mediawiki/index.php/Web_Portal_Tutorial_Guide

3.6 Changing Passwords

Once logged in to the TMG800, type “passwd”, in order to change the password being used. The following information will be displayed:

```
[root@TB003540 ~]# passwd
Changing password for user root.
New UNIX password:
Retype new UNIX password:
passwd: all authentication tokens updated successfully.
```

Chapter 4 System Upgrades

For information concerning system upgrades on a Telcobridges TMG800, refer to the Toolpack Install Guide for TMG800. This document can be found on the Telcobridges web site:

http://docs.telcobridges.com/mediawiki/index.php/Upgrading_Toolpack

4.1 Installing a New License

In order to install a new license on a Tmedia system, follow the steps described on the following internet page:

http://docs.telcobridges.com/mediawiki/index.php/Add/Change_Licenses

Note: A license upgrade involves an interruption of service.

Chapter 5 Troubleshooting Tools

This chapter provides guidance in what actions to take when encountering system problems prior to contacting TelcoBridges Customer Support.

The following topics are covered:

- Connecting to the Serial Port of the TMG800
- Configuring the Terminal Emulator Application
- Reporting a Problem
- Preparing Your Setup Information
- TbDebug Debug Dump Files
- Application Logs
- Backdoor Tools
- tbsigtrace Signaling Traces

5.1 Connecting to the Serial Port of the TMG800

The serial port interface enables administrators to perform management tasks on the TMG800.

To connect to the serial port of a Tmedia unit:

1. Connect a RJ45 CAT5 straight cable (supplied with unit) between the com port of your computer and the serial port (labelled RS-232) of the TMG800 as shown in figure 5.1 on page 24. See figure 5.3 on page 25 for a RJ-45 pinout description.
2. If your computer's serial port features a DB9 connector, use the DB9 to RJ45 adapter supplied with your Tmedia unit. If your computer's serial port features a USB connector, you will need to provide a USB to DB9 adaptor. Refer to figure 5.2 on page 24.

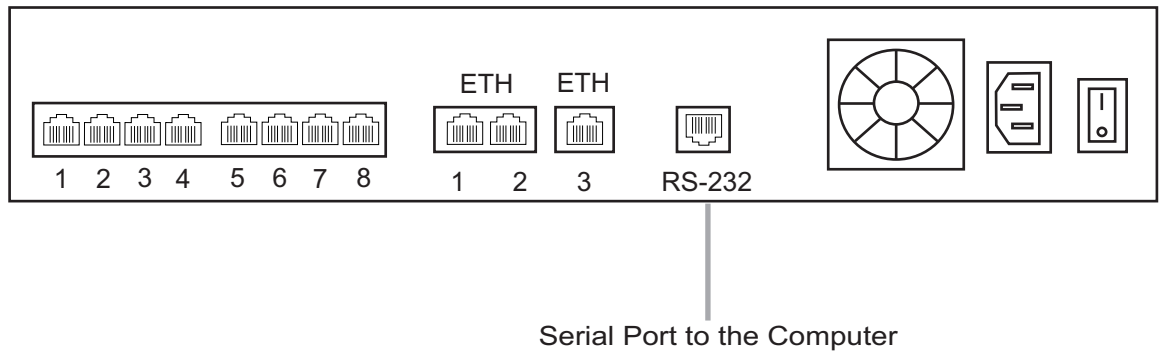

Figure 5.1 Computer to TMG800 Serial Port Connection

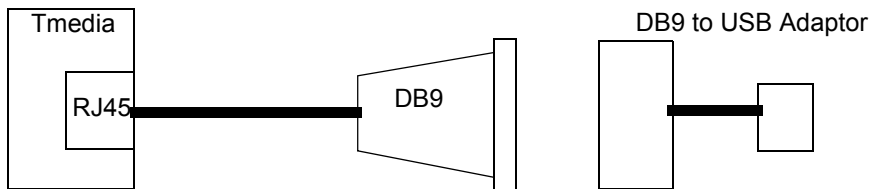

Figure 5.2 Conceptual View of a Serial Connection from the TMG800 to a Computer

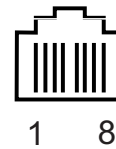
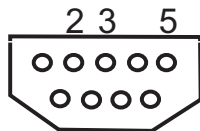
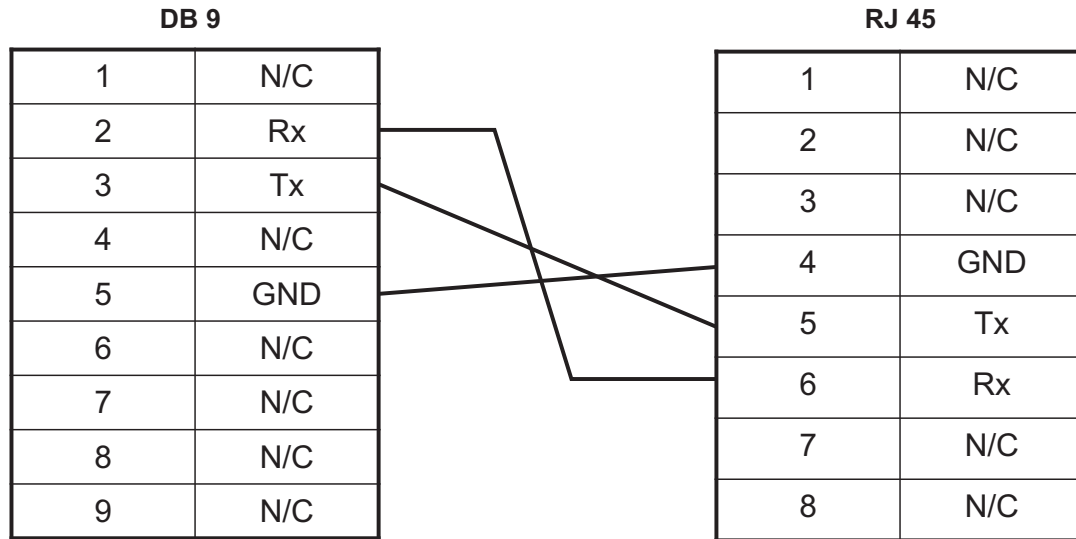

Figure 5.3 Console pinout

5.2 Configuring the Terminal Emulator Application

Before communicating with the Tmedia Management Interface, you must first configure a terminal emulator or console application to communicate with the TMG800 in order to configure initial settings. Available terminal emulation software includes:

- HyperTerminal
- Putty
- Minicom

To configure the terminal emulator application:

1. Set the baud rate (bits per second) to **9600**
2. Set the data rate to **8 bits**
3. Set the parity to **None**
4. Set the stop bits to **1**
5. Set the flow control to **None**

5.3 Reporting a Problem

TelcoBridges has developed extensive tools to gather information about a Tmedia system to solve problems quickly. Users **MUST** gather all related logs before reporting a problem to TelcoBridges Support via Email or MSN. Various logging methods are described in the following sections.

Once information is gathered and sent to the TelcoBridges Support group (support@telcobridges.com), the Support group will assign a tracking number to the problem. All follow-up correspondence, whether it be by E-mail, MSN, or phone call must refer to the tracking number which the problem has been assigned.

5.4 Setup Information

The setup information must include:

- Physical connections. If necessary, describe it in a network diagram.
- Specifying that your product is a TMG800.
- Telecommunication connectivity diagram (for example: E1/T1/J1, DS3, STM-1/OC-3, VoIP Ethernet switch, etc)
- Remote access to system (SSH, VPN, VNC, Remote desktop, etc.)
- For a signaling-related problem, specify which side is initiating the call

5.5 Tbdebug Dump Files (Mandatory)

The tbdebug copies information about Telcobridges libraries and TMG800 into log files. This includes the software release running on the host, the firmware release running on the TMG800, and other TMG800 information, such as: available features, configuration, and status information.

The tbdebug files must be sent when a problem is reported. If the problem is reproducible, the tbdebug dump files are verified before and after the problem is reproduced. This will aid in identifying the problem quickly.

For further information about Tbdebug, refer to Telcobridges TB Wiki at:

http://docs.telcobridges.com/mediawiki/index.php/Toolpack_Debug_Application:Tbdebug

5.6 Application Logs

All Toolpack applications will produce logs. The trace level can be set to vary the amount of logs that are received from the system. Trace level 0 is the most verbose and 4 is the least. Important errors are always logged.

`/lib/tb/toolpack/setup/[major version]/apps/gateway` (Or customer's application)

```
tblogtrace
tboamapp
tbstreamserver
toolpack_engine
toolpack_sys_manager
/lib/tb/toolpack/
tbtoolpack_service
```

```
/lib/tb/toolpack/pkg/[minor version]/web  
Log  
Database dump:  
mysqldump -u [DbUserName] -password=[DbPassword] -opt toolpack_0 > toolpack_0.sql  
  
For example: mysqldump -u tbdb -password=tbdbpw -opt toolpack_0 > toolpack_0.sql
```

Note This can be obtained from the web portal or by using the tbdebug command.

5.7 Backdoor Tools

A number of backdoor tools are available as follows:

- `tbx_cli_tools_remote`
- `tbshows`
- VoIP Traffic Capture
- Wireshark
- `tbstreamlisten`
- Stream server audio packets to wave file
- `tbsigtrace`

5.7.1 `tbx_cli_tools_remote`

The `tbx_cli_tools_remote` tool can be used to get the text-based GUI control of TB applications like `Toolpack_Engine`, `Toolpack_sys_manager`, `tbstreamserver`, and others which are run in background.

For further information about `tbx_cli_tools`, refer to Telcobridges TB Wiki at:

http://docs.telcobridges.com/mediawiki/index.php/Toolpack_Application:tbx_cli_tools_remote

5.7.2 Line/Trunk Status (Tbshowls)

```
tbshowls (/tb/bin/release/[OS version]/)
```

tbshowls can be used to show trunk alarm and performance counters. The tool will check the trunk status periodically to show the most updated trunk status. Users can use the up/down/left/right arrow keys to show the performance data on different trunks. Use a-s-d-x to scroll and view other lines services.

Options 'G' and 'S' enable you to get and set the trunk interface parameters.

Option 'R' can be used to reset the performance counter value to zero.

It is also possible to allocate all line interfaces in different configurations. This is useful for DS3 and OC3/STM-1 configurations, in order to help users understand the configuration.

Note Trunk status and alarms can be viewed from the *Status* menus of the Web Portal.

5.7.3 VoIP Traffic Capture

When troubleshooting VoIP related issues, a direct Ethernet connection can be established between the host's Gigabit Ethernet interface and the VoIP1 interface on the TMG800. Wireshark is connected on the Gigabit Ethernet interface on the host server.

To capture VoIP Traffic, do the following:

1. Connect VoIP1 interface to Ethernet port of a server
2. Connect to the telecom platform
 - 2a. Using telnet, for example: [root@TB005375]# telnet 172.31.1.1
or
 - 2b. Using minicom, for example: [root@TB005375]# minicom
3. Type this command:

```
mv88eMonitor 0x1 0x1 1 (Copies everything from VoIP0 to VoIP1)
                       (typing mv88eMonitor without any
                       parameters, displays the usage)
```
4. Start pcap capture on the server Ethernet port (either wireshark or tcpdump)
5. To stop the tracing:

```
mv88eMonitor 0 0 1
```

5.7.4 Wireshark (formerly called Ethereal)

Wireshark is useful for capturing both VoIP traffic as well as Streamserver packets (play/record function).

This program is available at this site: www.wireshark.org

5.7.5 Tbstreamlisten

`tb\apps\tbstreamlisten\release\[OS version]`

This allows the recording of the raw data from a TDM stream. Please ask customer support for instructions regarding this function.

5.7.6 Stream Server Audio Packets to Wave File

It is possible to capture all audio packets transmitted to and from the Stream Server and to convert them into wave files for analysis. You can use Wireshark or tcpdump on the server running the `tbstreamserver` application.

The conversion tool, `streamserver_pkt_to_wav` can be found at the following location:

`/tb/bin/release/[OS version]`.

5.7.7 tbsigtrace Signaling Traces

The `tbsigtrace` program is a tool used to capture SS7, ISDN, and SIP signaling.

Note This application can be started with Toolpack. For further information, refer to the TelcoBridges TB Wiki at:
http://docs.telcobridges.com/mediawiki/index.php/Toolpack_Debug_Application:Tbsigtrace
